



JE2212LED

22"LED TV User's Guide

- Please observe all safety precautions when using this product.
- Please read this manual careful

Guide de l'utilisateur du téléviseur LED de 22"

- Veuillez observer toutes les mesures de sécurité en utilisant ce produit.
- Veuillez lire soigneusement ce manuel avant d'utiliser ce produit.

English

Français

Safety Precautions

- Important Information 3
- Important Safeguards 4~5

User Guidance Information

- Names of each part(Front View) / Accessories..... 6
- Names of each part(Back View)..... 7
- Mounting on a Desktop / Installation Precautions 8
- Installing an Antenna 9
- Remote control 10~11
- Precautions / How to use remote control 12

Connection

- VCR Connections / Digital Amplifier Connections / Watching Video Tape 13
- Satellite/Cable TV Set-Top Box Connections / Watching Cable TV 14
- External Audio Amplifier / SERVICE USB Connections..... 15
- JENSEN DVD Connections for IR / PC Connections / How to use as PC monitor 16

Basic Use

- Powering the LED TV / Selecting input source / Initial Setup Wizard 17

Application

- Menu Operation 18
- Customizing the PICTURE Settings 19
- Customizing the AUDIO Settings 20
- Customizing the TIMER Settings 21
- Customizing the SETUP Settings 22~23
- Customizing the LOCK Settings 24~26
- Customizing the CHANNEL Settings 27~28

Maintenance and Service

- Trouble shooting 29
- Specifications 30

WARNING

To reduce the risk of fire or electric shock, do not expose this product to rain or moisture.

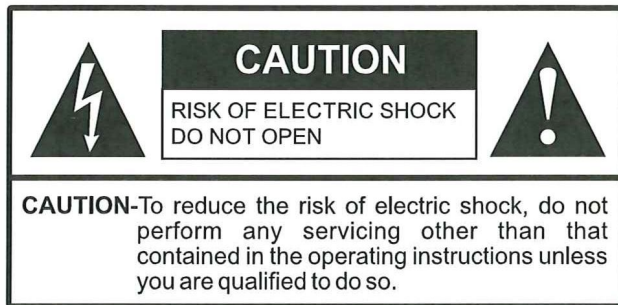

This symbol is intended to alert the user to the presence of uninsulated "dangerous voltage" within the product's enclosure that may be of sufficient magnitude to constitute a risk of electric shock to persons.



This symbol is intended to alert the user to the presence of important operating and maintenance (servicing) instructions in the literature accompanying the appliance.

This product utilizes tin-lead solder, and fluorescent lamp containing a small amount of mercury. Disposal of these materials may be regulated due to environmental considerations. For disposal or recycling information, please contact your local authorities or the Electronic Industries Alliance: www.eia.org

FCC STATEMENT

This product has been tested and found to comply with the limits for a Class B digital device, pursuant to part 15 of the FCC Rules. These limits are designed to provide reasonable protection against harmful interference when the equipment is operated in a commercial environment.

This product generates, uses, and can radiate radio frequency energy and, if not installed and used in accordance with the instruction manual, may cause harmful interference to radio communications. Operation of this equipment in a residential area is likely to cause harmful interference in which case the user will be required to correct the interference at his own expense.

FCC CAUTION:

Pursuant to 47CFR, Part 15.21 of the FCC rules, any changes or modifications to this monitor not expressly approved by the manufacturer could cause harmful interference and would void the user's authority to operate this device.

WARNING:

This is a **CLASS B** product. In a domestic environment, this product may cause radio interference, in which case the user may be required to take adequate measures to counter interference.

IMPORTANT SAFETY INSTRUCTIONS

- 1) Read these instructions.
- 2) Keep these instructions.
- 3) Heed all warnings.
- 4) Follow all instructions.
- 5) Do not use this product near water. Apparatus should not be exposed to dripping or splashing and no objects filled with liquids, such as vases, should be placed on the product.
- 6) Clean only with a dry cloth.
- 7) Do not block any ventilation openings. Install in accordance with the manufacturer's instructions.
- 8) Do not install near any heat sources such as radiators, heat registers, stoves, or other apparatus (including amplifiers) that produce heat.
- 9) Do not defeat the safety purpose of the polarized or grounding-type plug. A polarized plug has two blades with one wider than the other. A grounding type plug has two blades and a third grounding prong. The wide blade or the third prong are provided for your safety. If the provided plug does not fit into your outlet, consult an electrician for replacement of the obsolete outlet.
- 10) Protect the power cord from being walked on or pinched, particularly at plugs, convenience receptacles, and the point where they exit from the apparatus.
- 11) Only use attachments/accessories specified by the manufacturer.
- 12) Use only with the cart, stand, tripod, bracket, or table specified by the manufacturer or sold with the apparatus.
When a cart is used, use caution when moving the cart/apparatus combination to avoid injury from tip-over.
- 13) Unplug this apparatus during lightning storms or when unused for long periods of time.
- 14) Refer all servicing to qualified service personnel. Servicing is required when the product has been damaged in any way, such as power-supply cord or plug is damaged, liquid has been spilled or objects have fallen into the product, the product has been exposed to rain or moisture, does not operate normally, or has been dropped.
- 15) Where the mains plug or an appliance coupler is used as the disconnect device, the disconnect device shall remain readily operable.



Important Safeguards

Before using your TV, please read these instructions completely, and keep this manual for future reference. Carefully observe and comply with all warnings, cautions and instructions placed on the unit or described in the operating instructions or service manual.

WARNING

To guard against injury, the following basic safety precautions should be observed in the installation, use and servicing of the unit.

Power Sources

This unit should be operated only from the type of power source indicated on the information label.

If you are not sure of the type of electrical power supplied to your home, consult your dealer or local power company.

Grounding or Polarization

This unit is equipped with a polarized AC power cord plug (a plug having one blade wider than the other), or a DC power connection, for use in a vehicle. Follow the instructions below:

For the unit with a polarized AC power cord plug

This plug will fit into the power outlet only one way. This is a safety feature. If you are unable to insert the plug fully into the outlet, try reversing the plug. If the plug still fails to fit, contact your electrician to have a suitable outlet installed. Do not defeat the safety purpose of the polarized plug by forcing it in.



For the unit with a DC power connector

For installation in a vehicle, connect the red wire to the 12V accessory line and the black wire to a ground terminal.

Wall outlet

Do not use a poor fitting outlet.

Insert the plug fully into the outlet. If it is loose, it may cause arcing and result in fire. Contact your electrician to have the outlet changed.

Wiring

For your safety, unplug the power cord when wiring cables.

Electric shock

Do not touch the AC power cord or the unit with a wet hand. If you plug/unplug the AC power cord from the unit with a wet hand, it may cause electric shock.

Never attempt to move the unit unless the AC power cord is disconnected.

Cleaning

- Clean the power plug regularly.
- If the plug is covered with dust and it picks up moisture, its insulation may deteriorate and result in fire. Unplug the power plug and clean it regularly.
- Unplug the power cord when cleaning this unit. If not, it may result in electric shock.
- Clean the cabinet of the TV with a dry soft cloth. To remove dust from the screen, wipe it gently with a soft cloth.



- Stubborn stains may be removed with a cloth slightly dampened with a solution of mild soap and warm water. Never use strong solvents such as thinner or benzene for cleaning.
- If using a chemically pre-treated cloth, please follow the instructions provided on the package.

Overloading

Do not overload wall outlets, extension cords or convenience receptacles beyond their capacity, since this can result in fire or electric shock.

Power

Always turn the unit off when it is not being used.

When the unit is left unattended and unused for long periods of time, unplug it from the wall outlet as a precaution against the possibility of an internal malfunction that could create a fire hazard.

Sound

If a snapping or popping sound from the TV is continuous or frequent while the TV is operating, unplug the TV and consult your dealer or service technician. It is normal for TV's to make occasional snapping or popping sounds, particularly when being turned on or off.

Power Cord

If you damage the power cord, it may result in fire or electric shock.

- Do not pinch, bend, or twist the cord excessively. The core lines may be bared and cut and cause short-circuit, resulting in fire or electric shock.
- Do not convert or damage the power cord.
- Do not put anything heavy on the power cord. Do not pull the power cord.
- Keep the power cord away from heat sources.
- Be sure to grasp the plug when disconnecting the power cord. If the power cord is damaged, stop using it and replace with a new one.

Ventilation

The slots and openings in the TV are provided for necessary ventilation. To ensure reliable operation of the unit, and to protect it from overheating, these slots and openings must never be blocked or covered. Unless proper ventilation is provided, the unit may gather dust and get dirty. For proper ventilation, observe the following:

- Do not install the unit turned backward or sideways.
- Do not install the unit turned over or upside down.
- Never cover the slots and openings with a cloth or other materials.
- Never block the slots and openings by placing the unit on a bed, sofa, rug or other similar surface.
- Never place the unit in a confined space, such as a bookcase or built-in cabinet, unless proper ventilation is provided.
- Leave some space around the unit. Otherwise, adequate air-circulation may be blocked, causing overheating, and may cause fire or damage the unit.

Heat sources

Do not install near any heat sources such as radiators, heat registers, stoves, or other apparatus (including amplifiers) that produce heat.

Important Safeguards

Do not use this product near water

Do not use near a bathtub, washbowl, kitchen sink, or laundry tub, in a wet basement, or near a swimming pool.

Do not use immediately after moving from a low temperature to high temperature environment, as this causes condensation, which may result in fire, electric shock, or other hazards.

This product should not be exposed to dripping or splashing and no objects filled with liquids, such as vases, should be placed on the product.

Entering of objects and liquids

Never insert an object into the product through vents or openings. High voltage flows in the product, and inserting an object can cause electric shock and/or short internal parts. For the same reason, do not spill water or liquid on the product.

Lightning

Unplug this apparatus during lightning storms or when unused for long periods of time.

For added protection during a lightning storm, or when left unattended and unused for long periods of time, unplug the product from the wall outlet and disconnect the antenna. This will prevent damage to the equipment due to lightning and power-line surges.

Servicing

Refer all servicing to qualified service personnel. Servicing is required when the product has been damaged in any way, such as power-supply cord or plug is damaged, liquid has been spilled or objects have fallen into the apparatus, the apparatus has been exposed to rain or moisture, does not operate normally, or has been dropped.

Replacement parts

In case the product needs replacement parts, make sure the service person uses replacement parts specified by the manufacturer, or those with the same characteristics and performance as the original parts. Use of unauthorized parts can result in fire, electric shock and/or other danger.

Attachments

Only use attachments/accessories specified by the manufacturer. Do not use attachments not recommended by the manufacturer. Use of improper attachments can result in accidents.

Damage requiring service

If any of the following conditions occurs, unplug the power cord from the AC outlet and request a qualified service person to perform repairs.

- a. The power cord or plug is damaged.
- b. Liquid is spilled on the product or when objects have fallen into the product.
- c. The product has been exposed to rain or water.
- d. The product does not operate properly as described in the operating instructions.

Do not touch the controls other than those described in the operating instructions. Improper adjustment of controls not described in the instructions can cause damage, which often requires extensive adjustment work by a qualified technician.

- e. The product has been dropped or the cabinet has been damaged in any way.
- f. The product displays an abnormal condition or exhibits a distinct change in performance. Any noticeable abnormality in the product indicates that the product needs servicing.

Safety checks

Upon completion of service or repair work, request the service technician to perform safety checks to ensure that the product is in proper operating condition.

Wall or ceiling mounting

When mounting the product on a wall or ceiling, be sure to install the product according to the method recommended by the manufacturer. This is a safety feature.

Panel protection

The panel used in this product is made of glass. Therefore, it can break when the product is dropped or impacted upon by other objects. Be careful not to be injured by broken glass pieces if the panel breaks.

Pixel defect

Occasionally, a few non-active pixels may appear on the screen as a fixed point of blue, green or red. Please note that this does not affect the performance of your product.

Antennas

Outdoor Antenna Grounding

If an outdoor antenna is installed, follow the precautions below. An outdoor antenna system should not be located in the vicinity of overhead power lines or other electric light or power circuits, or where it can come in contact with such power lines or circuits.

WHEN INSTALLING AN OUTDOOR ANTENNA SYSTEM, EXTREME CARE SHOULD BE TAKEN TO KEEP FROM CONTACTING POWER LINES OR CIRCUITS AS CONTACT WITH THEM IS ALMOST INVARIABLY FATAL.

Be sure the antenna system is grounded to provide some protection against voltage surges and built-up static charges. Section 810 of the National Electrical Code (NEC) in USA and Section 54 of the Canadian Electrical Code in Canada provides information with respect to proper grounding of the mast and supporting structure, grounding of the lead-in wire to an antenna discharge unit, size of grounding conductors, location of antenna discharge unit, connection to grounding electrodes, and requirements for the grounding electrode.

Antenna Grounding According to the National Electrical Code, ANSI/NFPA 70

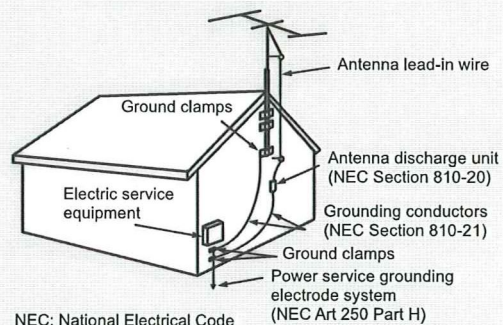

Names of each part

Front View

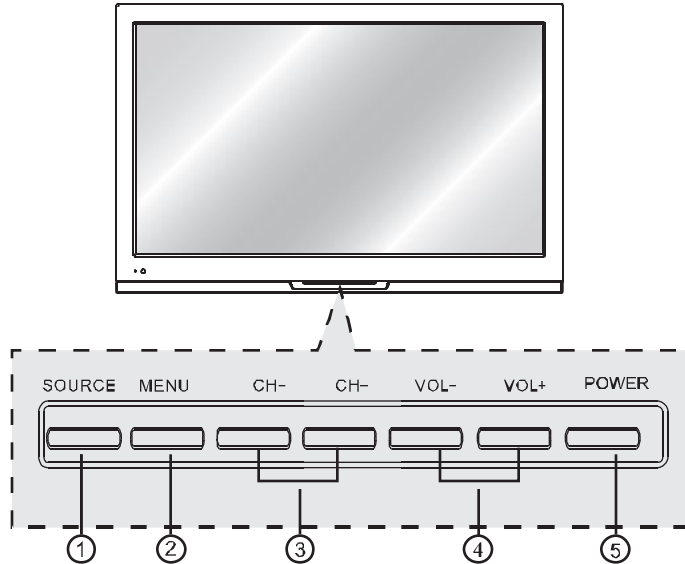

- ❶ SOURCE Button
- ❷ MENU Button-OSD Menu Display Button
- ❸ CH- / CH+ Button
- ❹ VOL- / VOL+ Button
- ❺ POWER Button

Accessories

- The configuration of the components may look different from the following illustration.



AV Cable



Battery 1.5V(AAA x2)



Power **Cable**



User's Guide



Remote Control

Names of each part

Back View

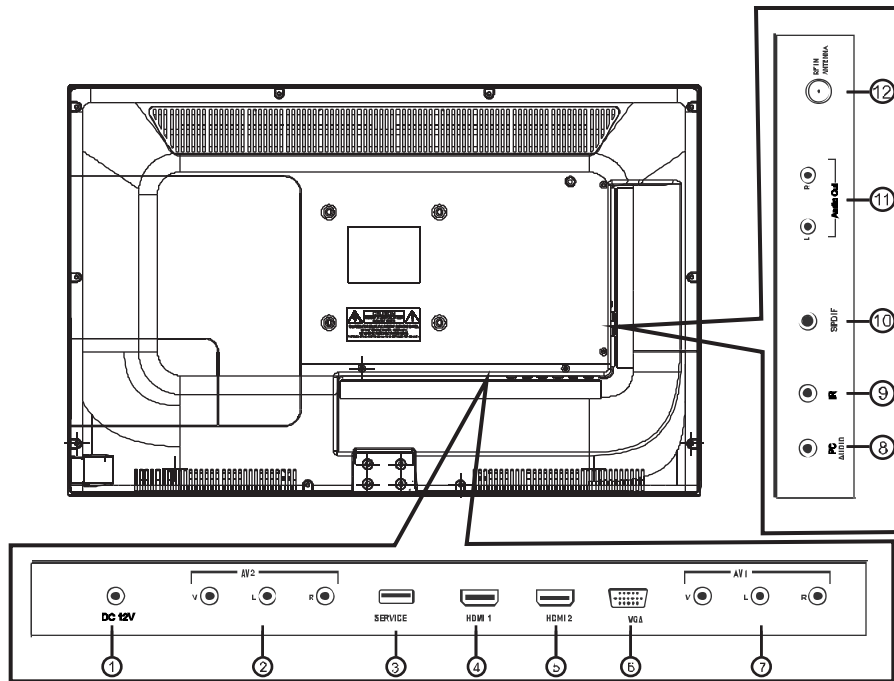

- | | | |
|----------------------------|-----------------------------|-----------------|
| ① DC 12V | ② AV2 IN (VIDEO and AUDIO) | ③ SERVICE jack |
| ④ HDMI 1 jack | ⑤ HDMI2 jack | ⑥ VGA |
| ⑦ AV1 IN (VIDEO and AUDIO) | ⑧ PC AUDIO | ⑨ IR jack |
| ⑩ SPDIF | ⑪ AUDIO(L/R) OUT | ⑫ RF(ATSC/NTSC) |

Mounting on a Desktop

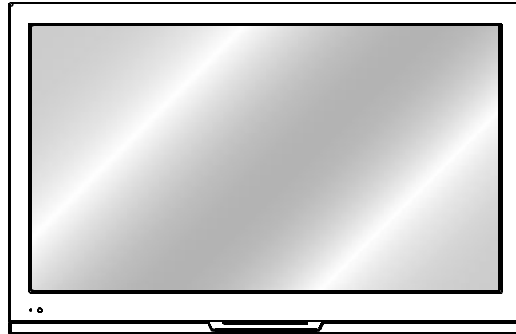

- Your LED TV can be mounted on a Desktop as shown in the figure above.
- This is not floor-standing unit.

Installation Precautions

Wall Mounting

- Please ensure enough space for safe use. (Please refer to A and B.)
- Installation of the LED TV in an improperly ventilated location can cause damage to the LED TV due to increased temperature.

A →
(Mounting on a wall)

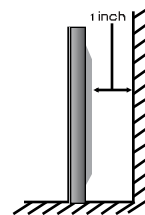
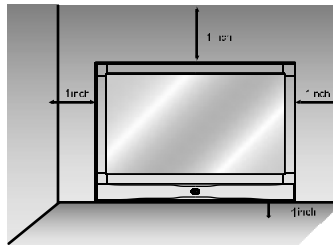

* Contact your dealer to purchase the "Adjustable-angle wall mount" required for wall-mounted installation.

Using the Stand

- Do not install on an unstable location with support area smaller than the LED TV.
- Please refer to the desktop stand user's manual for details of installation.

B →
(Using the Stand)

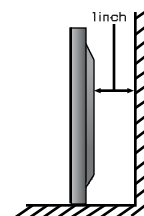
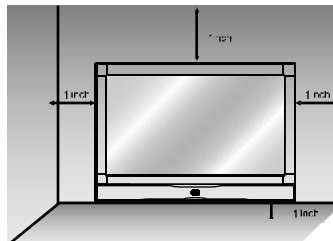

POWER input Connections



Installing an Antenna

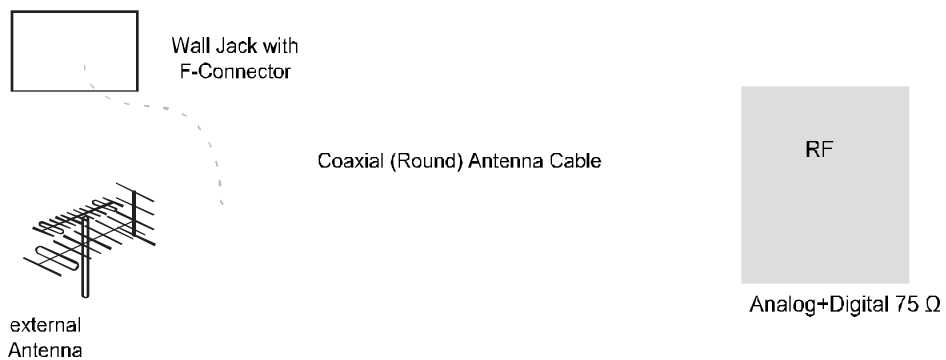

Press SOURCE button on the remote control to select TV, then press RIGHT button to confirm.
Then you can receive the ATSC/NTSC signal.



































Remote Control

● Functions of remote control buttons



①	TV	Activate TV Mode
②	POWER	On / off for TV and DVD
③	DVD	Activate DVD Mode
④	PREVIOUS(DVD)	
⑤	FAST REVERSE(DVD)	
⑥	FAST FORWARD(DVD)	
⑦	NEXT(DVD)	
⑧	EJECT(DVD)	
⑨	STOP(DVD)	
⑩	PAUSE(DVD)	
⑪	RPT(DVD)	Repeat Selection
⑫	T/F(DVD)	
⑬	ZOOM(DVD)	
⑭	SUB-T(DVD)	
⑮	DISP(DVD)	Display Time or Chapter information
⑯	SET UP(DVD)	
⑰	AUDIO(DVD)	
⑱	EQ(DVD)	
⑲	TITLE(DVD)	
⑳	C-LIST	Press C-LIST button to display the channel list
㉑	F-LIST	Press this button to display the favourite list
㉒	MTS/SAP	Press MTS/RPT to select Stereo,SAP or Mono
㉓	SOUND	Press SOUND to cycle select sound types: Standard/ Music/ Movie/ Personal
㉔	SLEEP	Cycles through the LCD TV sleep time:off/5/ 10/15/30/45/60/90/120/180/240 minutes
㉕	CC	Close Caption
㉖	SCALE	Cycles among scale mode:Wide,Cinemat,Normal,Zoom.
㉗	PICTURE	Press PICTURE to cycle select picture types: Standard/ Dynamic/ Soft/ Personal
㉘	MENU	Displays the OSD menu on the screen
㉙	NAVIGATION	Move up , down , left or right
㉚	INFORMATION	Press INFO to display a variety of information about current channel.
㉛	ENTER	Press ENTER to confirm your operation
㉜	EPG	Displays the program guide
㉝	EXIT	
㉞	CH+/CH-	Increase or Decrease channel
㉟	SOURCE	Displays AV Inputs
㊱	MUTE	Press once mutes audio,press again to restore audio
㊲	VOL+/VOL-	Increase or Decrease volume
㊳	NUMERIC KEYS	
㊴	+ -	Digital channel selection
㊵	RETURN	Return to previously viewed channel

Remote Control

BUTTON	TV-FUNCTION	DVD-FUNCTION	BUTTON	TV-FUNCTION	DVD-FUNCTION	BUTTON	TV-FUNCTION	DVD-FUNCTION
	POWER	POWER		EPG				STOP
	CH+ CH-				T-F			PLAY-PAUSE
	VOL+ VOL-	VOL+ VOL-			F.I.F.C.I			PREVIOUS
	RETURN			↔				FAST-REVERSE
	MUTE			1	1			FAST-FORWARD
	MENU			2	2			NEXT
	INFO			3	3			RPT
	UP	UP		4	4			ZOOM
	DOWN	DOWN		5	5			SUB-T
	LEFT	LEFT		6	6			DISP
	RIGHT	RIGHT		7	7			SETUP
	ENTER	OK		8	8			AUDIO
	SOURCE	SOURCE		9	9			EQ
	EXIT			0	0			TITLE
	MTS-SAP			SCALE			CC	
	F-LIST			C-LIST			SLEEP	
	PICTURE			SOUND				

NOTE: DVD functions are intended for JENSEN DVD players only.
See your JENSEN DVD manual for more information.

Precautions

Avoiding Remote Control Problems

1. Check the polarity (+,-) of the batteries in the remote control.
2. Check that the batteries are good.

Inserting Batteries in the Remote Control

1. Open the cover completely.
2. Insert the two supplied batteries (AA, 1.5V). Ensure that the polarities (+ and -) of the batteries are aligned correctly.
3. Slide back the cover.

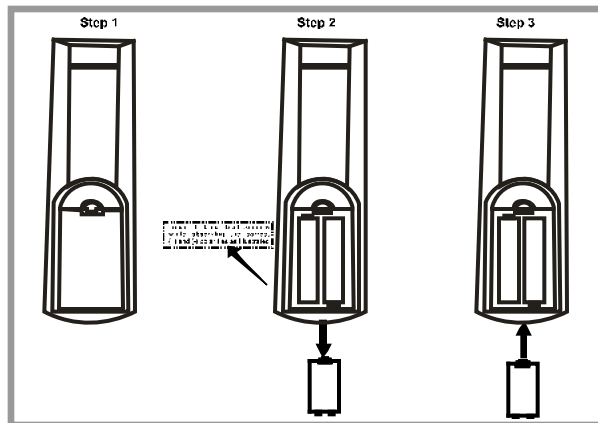

⚠ CAUTION : Risk of explosion if battery is replaced by an incorrect type.
Dispose of used batteries according to the national code (Recycling program).

How to use remote control

- The remote control should be operated within 30 feet (7m) and 30° to the left and the right of the IR receiver at the front of the LED TV.
- Used batteries should be disposed properly.

VCR Connections

- Connecting to the Composite terminal

※ Terminals vary by manufacturer

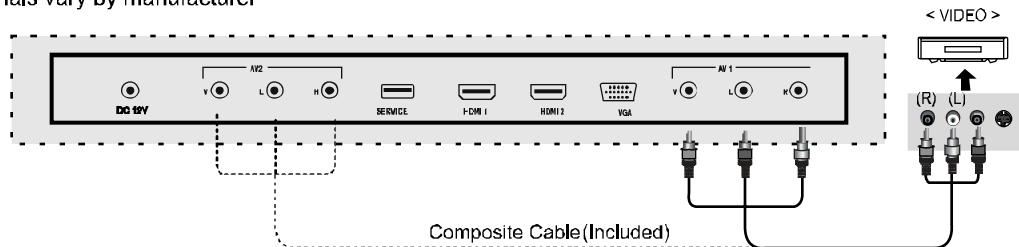

Connect the LED TV'S Composite In terminal to VCR's Composite OUT terminal using the included Composite cable.
(Make sure the color of the terminals and the color of the cable are the same)

Digital Amplifier Connections

- Connecting to a Digital Amplifier

※ Terminals vary by manufacturer.

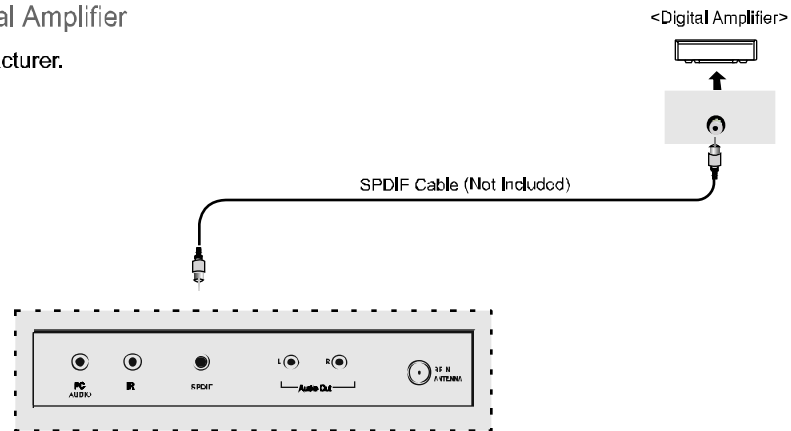

Watching Video Tape

1. Turn on the LED TV and press  on the remote control.

2. Use  to move to "AV 1 or 2".

3. Press  to confirm the source selection or stop operation a few seconds,
will automatically enter the selection mode.

4. Turn on the VCR, insert the tape and press play button.

Satellite/Cable TV Set-Top Box Connections

- Connecting to the Composite terminal

- ※ In order to watch Cable TV, Subscribe to your local Cable TV company and install a separate receiver(Set-Top-Box)
- ※ Terminals vary by manufacturer

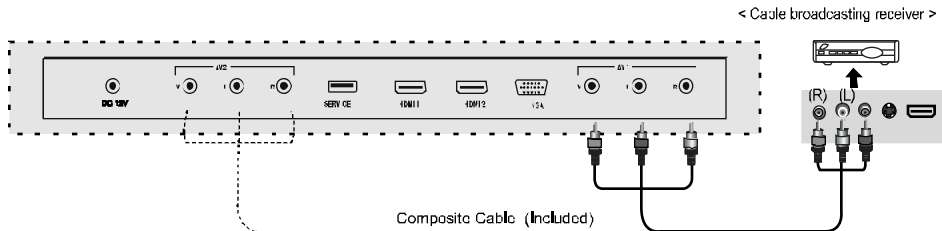

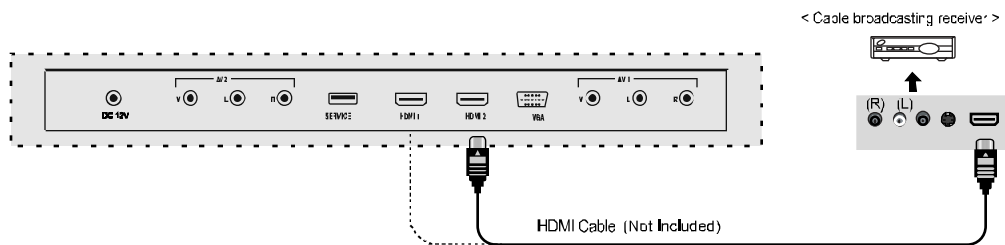

Connect the LED TV's Composite In terminal to the cable broadcasting receiver Composite Out terminal using the Composite cable. (Make sure the color of the terminals and the color of cable are the same)

- Connecting to the HDMI terminal



Watching Cable TV

1. Turn on the LED TV and press  on the remote control.
2. Use  to move to "AV 1 or 2". If HDMI has been connected, select "HDMI".
3. Press  to confirm the source selection or stop operation a few seconds, will automatically enter the selection mode.
4. Turn on the cable broadcasting receiver and select the channel you wish to view.

External Audio Amplifier

- Connecting to an amplifier or home theater system.
- ※ Terminals vary by manufacturer.

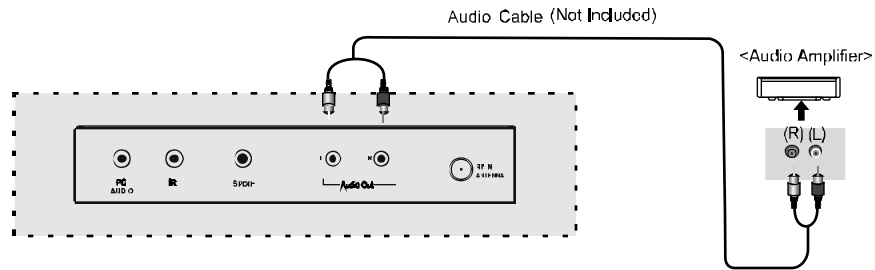

- Connect LED TV's AUDIO(L/R) output terminal to Audio Amplifier using an audio patch cable.
Note: The speakers of LED TV still have output audio signal at this time.
- You can use the Volume +/- buttons to adjust the audio output level.

SERVICE USB Connections

- ※ Connection to SERVICE USB.

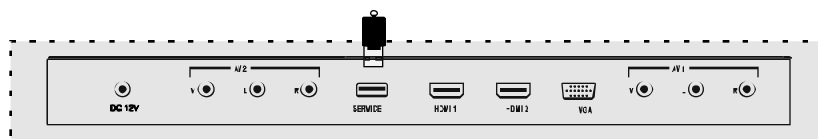

Note: This USB connection is for software upgrades only.
Does not support any other USB function .

JENSEN DVD Connections for IR

※ Connection to 12 volt JENSEN DVD player [IR control].

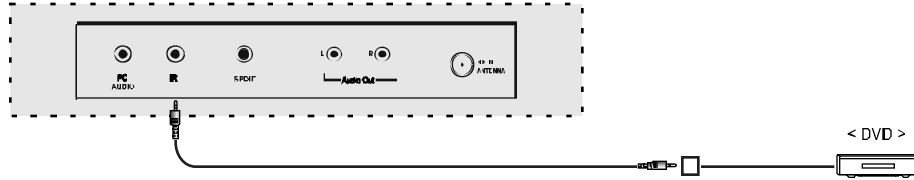

- All JENSEN Remote Control DVD Functions can be controlled Via the TV IR receiver.

You do not need to point the remote control at the JENSEN DVD player when this option is used.

NOTE: DVD IR control is intended for JENSEN DVD players only.
See your JENSEN DVD manual for more information.

PC Connections

※ Terminals vary by manufacturer.

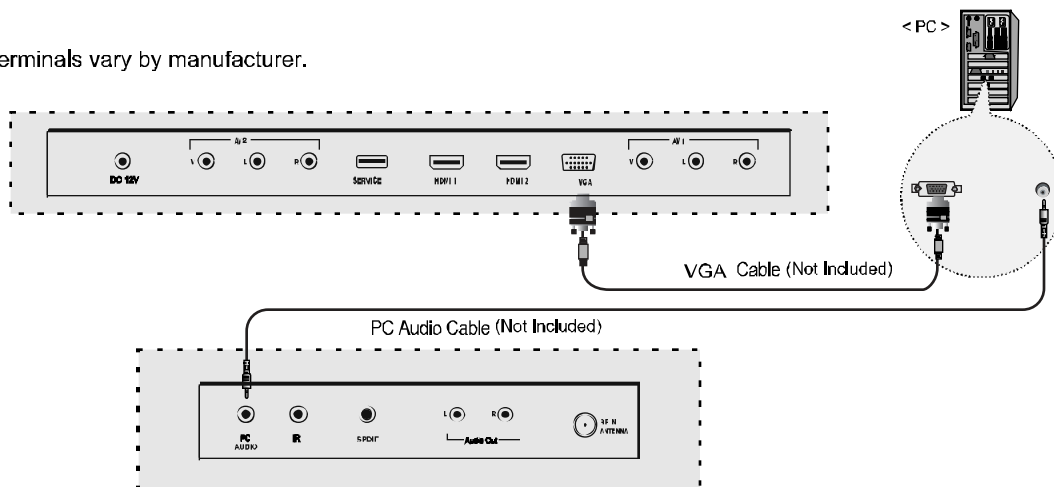

- Connect LED TV's PC Input terminal to PC's VGA terminal using a VGA cable.
- Connect LED TV's PC Audio terminal to PC's Audio terminal using a 3.5mm (Headphone) audio cable.
(Only for PC's with Audio terminal)

How to use as PC monitor

1. Turn on the LED TV and press **SOURCE** on the remote control.

2. Use **▲ ▼** to move to "VGA".

3. Press **ENTER** to confirm the source selection.

Selecting Input Source

- You can select between the TV signal and the input signal of other equipment connected to the TV.
- Use this function to switch to the input source you wish to view.

Press  button on the remote control.

Use  to move to the desired input source.

Press  to select.

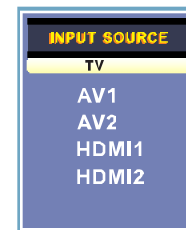

Note: After you selected the desired input source, if stop operation a few seconds, then will automatically enter the selection mode.

Initial Setup Wizard

After connecting your TV antenna or cable wire, turn the television ON. The quick setup wizard will display on-screen. Select your preferred picture setting followed by antenna options and performing Auto Scan to receive local broadcast channels that will be stored in the TV tuner memory.

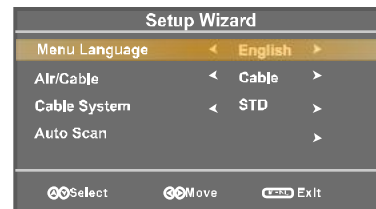

The wizard will direct you to the TV menu to select antenna options and run Channel Auto Scan. Channels found will be stored in the TV tuner memory.

How to Navigate:

- Press the ▲ ▼ arrow button to highlight Menu Language and then press ◀ ▶ button to select OSD Language.
- Press the ◀ ▶ arrow button to highlight **CABLE** or **AIR** based on your antenna connection.
- Press the ▼ arrow button to select **Auto Scan** and press **ENTER** (when Cable is selected, 'AUTO' is recommended). Otherwise, press the ◀ ▶ arrow button to select **Cable System**: STD > IRC > HRC > Auto.

Menu Operation

1. Press the POWER button to turn the LED TV on.
2. Press the MENU button on the remote control, the on-screen menu will appear.
3. Use the LEFT and RIGHT buttons to select your main menu option.

PICTURE MENU:

Allows you to make adjustments to your picture settings.
(select TV source for example)

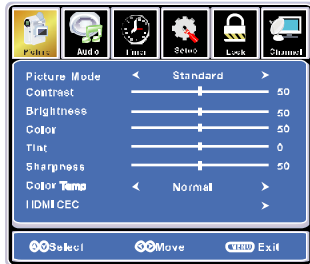

AUDIO MENU:

Allows you to customize the sound options and effects.
(Select TV source for example)

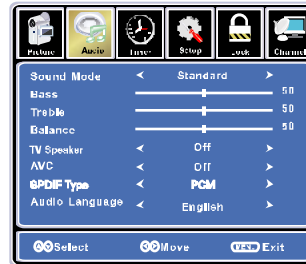

TIMER MENU:

Allows you to set up a variety of time options.
(Select TV source)



SETUP MENU:

Allows you to set up a variety of setup options.
(Select TV source)

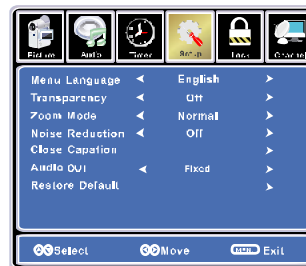

LOCK MENU:

Allows you to set up a variety of lock options.
(Select TV source)

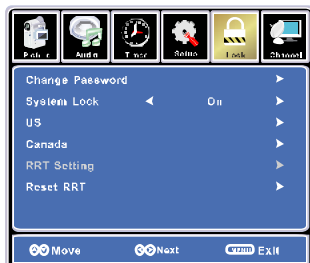

CHANNEL MENU:

Allows you to search channels and set up a variety of channel options.
(Select TV source)

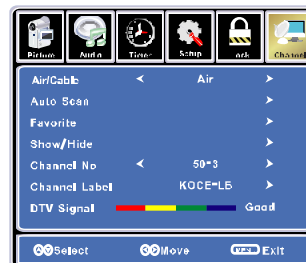

4. Use the UP / DOWN buttons to select an option of the sub-menu, and press the RIGHT button.
While in adjustment mode, use the LEFT/RIGHT button to change the value of the item.
5. Press the MENU button to exit submenu to return to the main menu.
Press the MENU button again or EXIT button to exit the main menu.

Note:

Some options are not available for all inputs.

Customizing the PICTURE Settings

Select TV source for example. (Press SOURCE button to select TV mode)

1. Press the POWER button to turn the LED TV on.
2. Press the MENU button on the remote control to display the Main menu, and use the LEFT and RIGHT buttons to select the PICTURE.
3. Use the UP and DOWN buttons to highlight an individual PICTURE option, use the LEFT and RIGHT buttons to change the setting, and press the MENU or EXIT button to exit.

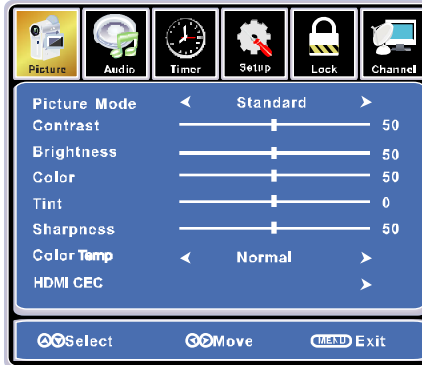

The PICTURE menu includes the following options :

Picture Mode	Cycles through picture display modes: Standard, Dynamic, Mild, User.
Contrast	Controls the difference between the brightest and darkest regions of the picture.
Brightness	Controls the overall brightness of the picture
Color	Controls the color.
Tint	Controls the tint.
Sharpness	Increase this setting to see crisp edges in the picture; decrease it for soft edges .
Color Temp	Cycles through color modes: Normal, Cool, Warm.
HDMI CEC	

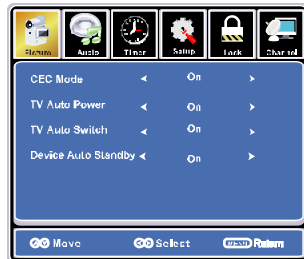

If you turn off the CEC Mode then the following items(TV Auto Power,TV Auto Switch,Device Auto Standby) will not be used.

TV Auto Power	On-TV will turn on when compatible CEC device is activated on HDMI connection.
TV Auto Switch	On-TV will switch to HDMI inputs when compatible CEC device is activated on HDMI connection.
Device Auto Standby	On-When TV turned off, any connected, compatible CEC device will also turn off.

Customizing the Audio Settings

Select TV source for example. (Press SOURCE button to select TV mode)

1. Press the POWER button to turn the LED TV on
2. Press the MENU button on the remote control to display the Main menu, and use the LEFT and RIGHT buttons to select the Audio
3. Use the UP and DOWN buttons to highlight an individual Audio option, use the LEFT and RIGHT buttons to change the setting, and press the MENU or EXIT button to exit

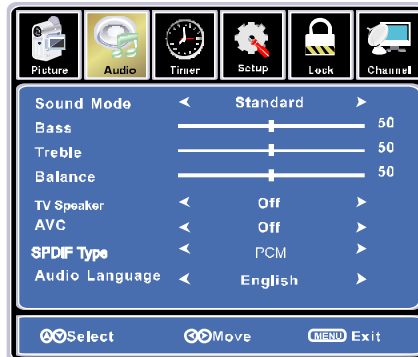

The SOUND menu includes the following options :

Sound Mode	Cycles through sound modes: Standard, Music, Movie and User.
Bass	Controls the relative intensity of lower pitched sounds.
Treble	Controls the relative intensity of higher pitched sounds
Balance	To adjust the balance of the left and right sound track, or turn off the volume of the left and right sound track.
TV Speaker	Allows you to select between ON and OFF.
AVC	On or off (Automatic Volume Control) keep volume level steady.
SPDIF Type	Allows you to select between PCM and RAW (Digital connection to Home Theater system)
Audio Language	Allows you to select audio languages: English, French and Spanish.

Customizing the TIMER Settings

Select TV source for example. (Press SOURCE button to select TV mode)

1. Press the POWER button to turn the LED TV on.
2. Press the MENU button on the remote control to display the Main menu, and use the LEFT and RIGHT buttons to select the TIMER.
3. Use the UP and DOWN buttons to highlight an individual TIMER option, use the LEFT and RIGHT buttons to change the setting, and press the MENU or EXIT button to exit.



The TIMER menu includes the following options :

Sleep Timer	Allows you to set up the sleep timer : 5min, 10min, 15min, 30min, 45min, 60min, 90min, 120min, 180min, 240min and off.
Time Zone	Allows you to select correct time zone: Pacific, Alaska, Hawaii, Eastern, Central and Mountain.
Daylight Saving Time	Allows you to turn on or off the daylight saving time.

Customizing the SETUP Settings

Select TV source for example. (Press SOURCE button to select TV mode)

1. Press the POWER button to turn the LED TV on.
2. Press the MENU button on the remote control to display the Main menu, and use the LEFT or RIGHT button to select the SETUP.
3. Use the UP and DOWN buttons to highlight an individual SETUP option, use the LEFT and RIGHT buttons to change the setting, and press the MENU or EXIT button to exit.

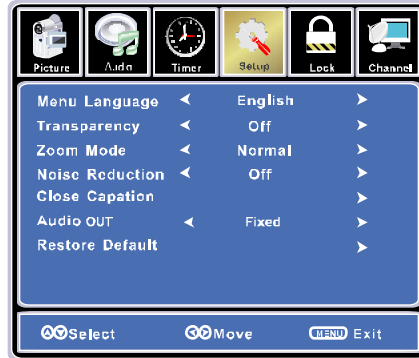

The SETUP menu includes the following options:

Menu Language	Allows you to select menu languages: English, Français and Español.
Transparency	Allows you turn on or off the transparency function of on screen menu.
Zoom Mode	Allows you to select the zoom modes: Normal, Cinema, Wide and Zoom.
Noise Reduction	Allows you to select the noise reduction modes: Strong, Off, Weak, Middle.

Customizing the SETUP Settings

Close Caption

Use Down button to highlight “Close Caption”, then press RIGHT button or ENTER to enter into the following menu.

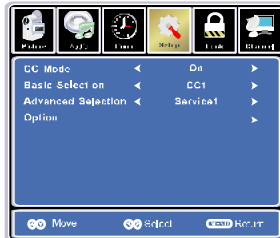

CC Mode

Allows you to select the CC Modes: On, Off and CC on Mute.

Basic Selection

Allows you to select the basic selections: CC1, CC2, CC3, CC4, Text1, Text2, Text3 and Text4.

Advanced Selection

Allows you to select the advanced services: Service1, Service2, Service3, Service4, Service 5 and Service 6.

Option

Use Down button to highlight the “Option” item, then press RIGHT button to enter into the following menu.



Use UP and DOWN buttons to highlight the desired item, and use LEFT and RIGHT buttons to select.

Audio Out

Allows you to select between Variable and Fixed.

Restore Default

Restores all settings in SETUP menu to factory settings.

Customizing the LOCK Settings

Select TV source for example. (Press SOURCE button to select TV mode)

1. Press the POWER button to turn the LED TV on
2. Press the MENU button on the remote control to display the Main menu, and use the LEFT and RIGHT buttons to select the LOCK
3. Use the DOWN button to highlight "Enter Password", use the numeric keys to input 4-digit password. After that, the screen will display the next menu. After setting, press menu or exit button to exit.

NOTE: The factory password is 0000.

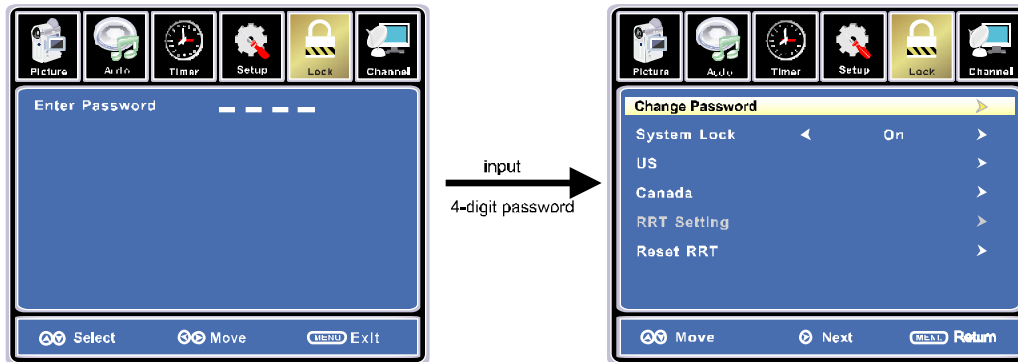

The LOCK menu includes the following options :

Change Password

Use DOWN button to select "Change Password", then press RIGHT or ENTER button to enter into the following menu.



Input the new 4-digit password and confirm it.

System Lock

Allows you to turn On or Off the system lock. If you turn off the system lock, then the following items(US, Canada, RRT Setting and Reset RRT) will not be used.

Customizing the LOCK Settings

US Use Down button to highlight “US”, then press RIGHT or ENTER button to enter into the following menu.

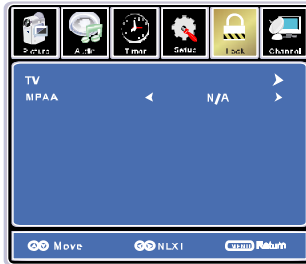

TV Use Down button to highlight “TV”, then press RIGHT or ENTER button to enter into the following menu.

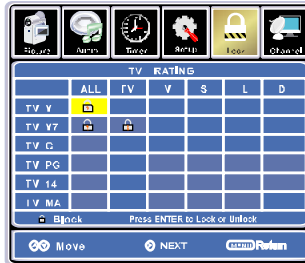

Use UP and DOWN buttons to select the desired rating and press ENTER button to block or unblock rating.

MPAA The Movie rating (MPAA) is used for original movies rated by the Motion Picture Association of America (MPAA) as broadcasted on cable TV and not edited for television. Use UP or DOWN button to select N/A, G, PG, PG-13, R, NC-17 or X.

RATING	DESCRIPTION
G	General Audiences. Movie is appropriate for all ages.
PG	Parental Guidance Suggested. May contain material not suited for younger viewers.
PG-13	Contains content that may not be appropriate for viewers under the age of 13.
R	Restricted. Contains adult content, no one under 17 admitted without parent.
NC-17	No one 17 and under admitted.
X	Adults only.

Customizing the LOCK Settings

Canada

Use Down button to highlight "Canada", then press RIGHT or ENTER button to enter into the following menu.



Canada English Use LEFT and RIGHT buttons to select among: E, C, C8+, G, PG, 14+ and 18+

Canada French Use LEFT and RIGHT buttons to select among: E, G, 8ans+, 13ans+, 16ans+ and 18ans+

RRT Setting

Reset RRT

Allows you to reset the RRT setting.

Customizing the CHANNEL Settings

Select TV source for example. (Press SOURCE button to select TV mode)

1. Press the POWER button to turn the LED TV on.
2. Press the MENU button on the remote control to display the Main menu, and use the LEFT and RIGHT buttons to select the CHANNEL.
3. Use the UP and DOWN buttons to highlight an individual CHANNEL option, use the LEFT and RIGHT buttons to change the setting, and press the MENU or EXIT button to exit.

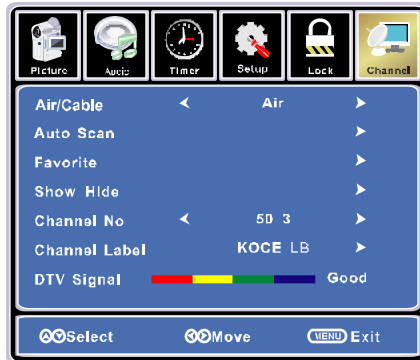

The CHANNEL menu includes the following options :

Air/Cable Allows you to select between Air and Cable.

Auto Scan Use Down button to highlight "Auto Scan", then press RIGHT or ENTER button to enter into the following menu.



If you select "Air" as input signal in Antenna , you can press RIGHT or ENTER button to search the channels automatically.

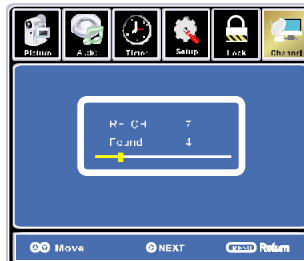

The receivable channels will be stored automatically.
When searching channels, press MENU to stop.

Customizing the CHANNEL Settings

If you select "Cable" as input signal in Antenna then you can select Cable Systems: Auto, STD, IRC and HRC.
 Use DOWN button to highlight "Start to Scan", then press RIGHT or ENTER button to search the channels automatically.
 The receivable channels will be stored automatically.
 When searching channels, press MENU to stop.

Favorite

Allows you to add these channels as the favorite channels.
 Use UP or DOWN button to highlight "Favorite", then press RIGHT or ENTER button to enter into the following menu.



Use UP and DOWN button to highlight the desired channel, then press ENTER button to add or remove the highlighted channel as favorite.

Show / Hide

Allows you to show or hide the channels.
 Use UP or DOWN button to highlight "Show / Hide", then press RIGHT or ENTER button to enter into the following menu.



Use UP and DOWN button to highlight the desired channel, then press ENTER button to show or hide the highlighted channel.

Channel No. Displays the number of current channel.

Channel Label Displays the label of current channel.

DTV Signal Displays the quality of current DTV signal.

- In case a problem occurs with your LED TV, please take the following steps first.
- If you still have the problem, turn the power off and contact your dealer or an authorized service center.

Problem	Action
The screen does not appear.	Is the power plug connected? Insert the power plug. Press the power button of the remote control.
The screen appears too slowly after the power is turned on.	This problem occurs for a brief time in the process of image elimination processing in order to hide temporary screen noise that occurs when the power is turned on. But if the screen does not come after 1 minute contact your dealer or an authorized service center.
Screen is too bright or too dark.	Perform brightness adjustment or Contrast adjustment.
Screen is too large or too small.	Adjust the screen size.
Stripes appear on the screen and it shakes.	Stop using wireless telephones, hair dryers and electric drills.
The screen does not move.	Press the PAUSE button. Check if the Pause button is pressed on external equipment.
Screen appears, Voice is not heard	<ol style="list-style-type: none"> 1. Press the "MUTE"button. 2. Increase the sound level by pressing volume adjustment button. 3. Check if sound terminal of external input is connected properly. 4. Check if audio cables are connected properly. 5. Select and check the other input. <p>If the sound still does not work and the other channels are the same after you have done as the above, contact your dealer or an authorized service center.</p>
Remote control does not work	<ol style="list-style-type: none"> 1. Check if main power is On. 2. Check that the batteries of the remote controller were loaded properly. 3. Check to see if any obstacle exists between the LED TV and the remote control , then remove it, if any. 4. If the batteries are low, replace them with two new batteries.

Specifications

LED Panel	Panel Size	22" TFT LED
	Brightness	250
	Contrast Ratio	1000:1
	Viewing Angle	170°/160°
Max. Resolution		1920 x 1080
INPUT	VIDEO	2
	AUDIO (L/R)	2
	PC/AUDIO(L/R)	1
	HDMI	2
	RF	1
OUTPUT	IR	1
	AUDIO (L/R)	1
	SPDIF	1
Power Source		DC 12V 3.3A
Power Consumption		40W
Dimension		529W x 348H x 48D mm
Weight		5.3 Kg

- The cabinet design and electronics specifications will be modified without prior notice for performance improvement.
- Weight and dimensions are approximate